

Industrial Ethernet Switch - FL SWITCH 2212-2TC-2SFX



2702907

<https://www.phoenixcontact.com/us/products/2702907>

Please be informed that the data shown in this PDF document is generated from our Online Catalog. Please find the complete data in the user documentation. Our General Terms of Use for Downloads are valid.



Managed Switch 2000, 12 RJ45 ports 10/100 Mbps, 2 SFP ports 100 Mbps, 2 Combo ports 10/100 Mbps, PROFINET Conformance-Class B

Your advantages

- MRP (client and manager)
- VLANs
- RSTP
- Ambient temperature -40 °C ... 70 °C
- DHCP client, DHCP server (pool-based and port-based), DHCP option 82
- Configuration memory
- Web-based management, SNMP
- Easy and fast startup and commissioning with the FL NETWORK MANAGER software
- Suitable for PROFINET and EtherNet/IP™ networks

Commercial Data

Item number	2702907
Packing unit	1 pc
Minimum order quantity	1 pc
Note	Made to Order (non-returnable)
Sales Key	C23
Product Key	DNN121
Catalog Page	Page 313 (C-6-2019)
GTIN	4055626398709
Weight per Piece (including packing)	675 g
Weight per Piece (excluding packing)	480 g
Customs tariff number	85176200
Country of origin	DE

Industrial Ethernet Switch - FL SWITCH 2212-2TC-2SFX



2702907

<https://www.phoenixcontact.com/us/products/2702907>

Technical Data

Dimensions

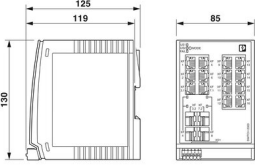
Dimensional drawing	
Width	85 mm
Height	130 mm
Depth	119 mm

Notes

General	Support by phone or on-site (fee is charged)
Utilization restriction	
CCCex note	Use in potentially explosive areas is not permitted in China.

Material specifications

Housing material	Polycarbonate fiber reinforced
------------------	--------------------------------

Mounting

Mounting type	DIN rail mounting
---------------	-------------------

Interfaces

Ethernet (RJ45)

Connection method	RJ45
Note on the connection method	Auto negotiation and autocrossing
Transmission speed	10/100 Mbps
Transmission physics	Copper
Transmission length	100 m (per segment)
Signal LEDs	Data receive, link status
No. of channels	12 (RJ45 ports)

SFP module

Number of interfaces	2
Connection method	SFP ports
Transmission speed	100 Mbps (full duplex)
Transmission physics	Depending on the SFP module
Transmission length	up to 40 km (Depending on the fiber/SFP module used)
Signal LEDs	Data receive, link status
No. of channels	2 (SFP ports)

Industrial Ethernet Switch - FL SWITCH 2212-2TC-2SFX



2702907

<https://www.phoenixcontact.com/us/products/2702907>

Ethernet (combo)

Number of interfaces	2
Connection method	SFP or RJ45 ports
Note on the connection method	Auto negotiation and autocrossing
Transmission speed	10/100 Mbps (full duplex)
Transmission physics	Depending on the SFP module
Transmission length	up to 40 km (Depending on the fiber/SFP module used)
Signal LEDs	Data receive, link status
No. of channels	2 (Combo ports)

Output data

Digital

Output name	Alarm output
-------------	--------------

Product properties

Type	Book type
Product type	Switch
MTTF	331.51 Years (SN 29500 standard, temperature 25°C, operating cycle 21%)
	185.67 Years (SN 29500 standard, temperature 40°C, operating cycle 34.25%)
	28.57 Years (SN 29500 standard, temperature 55°C, operating cycle 100%)
Signal delay	≥ 6.5 μs (Store and Forward mode, 10/100 Mbps, depending on the frame size)

Insulation characteristics

Protection class	III (VDE 0106)
Degree of pollution	2

Switch functions

Diagnostic functions	RMON History
	LLDP (Link Layer Discovery Protocol)
	SNMP-Traps
	N:1-Portmirroring
	ACD (Address Conflict Detection)
	SysLog
	CRC-Surveillance
Basic functions	Store-and-forward switch, complies with IEEE 802.3
Signal contact control voltage	typ. 24 V DC
PROFINET conformance class	Conformance-Class B
PROFINET device function	PROFINET device
	Fast Startup
Filter functions	Quality of Service (8 priority classes)
	Class of Service

Industrial Ethernet Switch - FL SWITCH 2212-2TC-2SFX



2702907

<https://www.phoenixcontact.com/us/products/2702907>

	DiffServ/DSCP
	Port-Priorisierung
	VLAN (up to 32 VLANs)
	IGMP Snooping/Querier (v1/v2)
	Auto-Query-Port
	Extended Multicast Filtering
IP parameterization	DHCP-Client
	DHCP Option 82 (Relay Agent)
	DHCP server (pool-based, port-based)
	BootP
	DCP (Discovery and Configuration Protocol)
MAC address table	8k
Management	Web-based management (HTTP/HTTPS)
	Role-based user management (LDAP, RADIUS)
	SNMPv1/v2/v3
	Command-line interface (Telnet, SSH)
Redundancy	MRP (Media Redundancy Protocol)
	RSTP (Rapid Spanning Tree Protocol)
	FRD (Fast Ring Detection)
	Large Tree Support
	LACP (Link Aggregation Control Protocol)
	PROFINET S2 system redundancy
Status and diagnostic indicators	LEDs: US1, US2 (power supply), Fail (alarm contact), 2 LEDs per Ethernet port (Link/Activity and Speed)
Additional functions	Transmission of MMS and GOOSE (IEC 61850-8-1)
	Transmission of Modbus/TCP
Time synchronization	SNTP (Simple Network Time Protocol)
Security functions	
Port security	MAC-based, RADIUS (IEEE 802.1X), MAC Authentication Bypass
Basic functions	Store-and-forward switch, complies with IEEE 802.3

Electrical properties

Local diagnostics	US1/2 Supply voltage US1, US2 Green LED
	FAIL Div. LED red
	LNK/ACT Link status Green LED
	SPD Data transmission speed Green LED
Maximum power dissipation for nominal condition	12 W ($U_S = \text{Min}$, $T_{\text{amb}} = \text{Max}$, $DO_I = \text{Max}$)
Test voltage	500 V DC
Test section	for one minute 500 V DC
Transmission medium	Copper
	FO

Supply

Industrial Ethernet Switch - FL SWITCH 2212-2TC-2SFX



2702907

<https://www.phoenixcontact.com/us/products/2702907>

Supply voltage (DC)	24 V DC (redundant)
Supply voltage range	12 V DC ... 57 V DC
Power supply connection	via COMBICON, max. conductor cross section 1.5 mm ²
Residual ripple	3.6 V _{PP} (within the permitted voltage range)
Max. current consumption	1.7 A (U _S = Min, T _{amb} = Max, DO _I = Max)
Typical current consumption	360 mA (at U _S = 24 V DC and 25 °C ambient temperature)
Current consumption	360 mA

Function

Signal contact control voltage	typ. 24 V DC
--------------------------------	--------------

Connection data

Connection method	Push-in spring connection
Note on the connection method	Use only copper connecting cables providing the permitted temperature range (-40 °C ... 75 °C).
Conductor cross section, rigid	0.25 mm ² ... 1.5 mm ²
Conductor cross section, flexible	0.25 mm ² ... 1.5 mm ²
Conductor cross section AWG	24 ... 16
Stripping length	9 mm

Ambient conditions

Degree of protection	IP20
Ambient temperature (operation)	-40 °C ... 70 °C
Ambient temperature (storage/transport)	-40 °C ... 85 °C
Permissible humidity (operation)	10 % ... 95 % (non-condensing)
Permissible humidity (storage/transport)	10 % ... 95 % (non-condensing)
Shock (operation)	30g (EN 60068-2-27)
Vibration (operation)	in acc. with IEC 60068-2-6: 5g, 150 Hz
Air pressure (operation)	79 kPa ... 108 kPa up to 2000 m above mean sea level (Without derating)
Air pressure (storage/transport)	79 kPa ... 108 kPa up to 2000 m above mean sea level (Without derating)

Standards and regulations

Free from substances that could impair the application of coating	Yes
---	-----

Approval data

Shipbuilding approval	Tested in accordance with IEC 60945 and IACS E10
-----------------------	--

ATEX

Identification	□ II 3 G Ex ec IIC T4 Gc
Certificate	DEMKO 16 ATEX 1709X

IECEX

Identification	Ex ec IIC T4 Gc
Certificate	IECEX ULD 16.0018 X

Industrial Ethernet Switch - FL SWITCH 2212-2TC-2SFX



2702907

<https://www.phoenixcontact.com/us/products/2702907>

UL, USA / Canada

Identification	cULus
----------------	-------

UL Ex, USA / Canada

Identification	Class I, Division 2, Groups A, B, C, and D, T4
	Class I, Zone 2, AEx ec IIC T4
	Ex ec IIC T4 Gc X
Certificate	E366272
Note	UL 60079-0 Ed. 6 / UL 60079-7 Ed. 5, CSA 22.2 No. 60079-0 Ed. 3 / CSA C22.2 No. 60079-7 Ed. 2

EAC Ex

Identification	2Ex e IIC T4 Gc X
Certificate	RU C-DE.HB49.B.00118/21

The following continue to apply for EAC Ex:

Identification	При монтаже использовать подходящий допущенный корпус со степенью защиты не ниже IP66.
	На корпусе/шкафу управления должна быть размещена предупреждающая надпись, запрещающая открывать корпус или шкаф во взрывоопасной зоне.
	Эксплуатация устройства допускается только при условии, что все оптические порты заняты подключенными устройствами или закрыты прилагаемыми заглушками.

CCC / China-Ex

Identification	Ex nA IIC T4 Gc
Certificate	2022122310115629

Corrosive gas test

Identification	ISA S71.04.2013 G3 Harsh Group A
----------------	----------------------------------

DNV GL data

Temperature	B
Humidity	B
Vibration	A
EMC	B
Enclosure	Required protection according to the Rules shall be provided upon installation on board

EMC data

Conformance with EMC directives	EN 61000-6-2 EN 61000-4-2 (ESD) Criterion B
	EN 61000-6-2 EN 61000-4-3 (electromagnetic fields) Criterion A
	EN 61000-6-2 EN 61000-4-4 (EFT burst) Criterion A
	EN 61000-6-2 EN 61000-4-5 (surge) Criterion A
	EN 61000-6-2 EN 61000-4-6 (line noise immunity) Criterion A
	EN 61000-6-2 EN 61000-6-3 (noise emission) Class B
	EN 61000-6-2 EN 61000-6-3 (conducted emissions) Class B

Industrial Ethernet Switch - FL SWITCH 2212-2TC-2SFX



2702907

<https://www.phoenixcontact.com/us/products/2702907>

Electromagnetic compatibility	Conformance with EMC Directive 2014/30/EU
Noise emission	EN 61000-6-4
Noise immunity	EN 61000-6-2

LED signaling

Status display	LEDs: US1, US2 (power supply), Fail (alarm contact), 2 LEDs per Ethernet port (Link/Activity and Speed)
----------------	---

Industrial Ethernet Switch - FL SWITCH 2212-2TC-2SFX



2702907

<https://www.phoenixcontact.com/us/products/2702907>

Drawings

Dimensional drawing

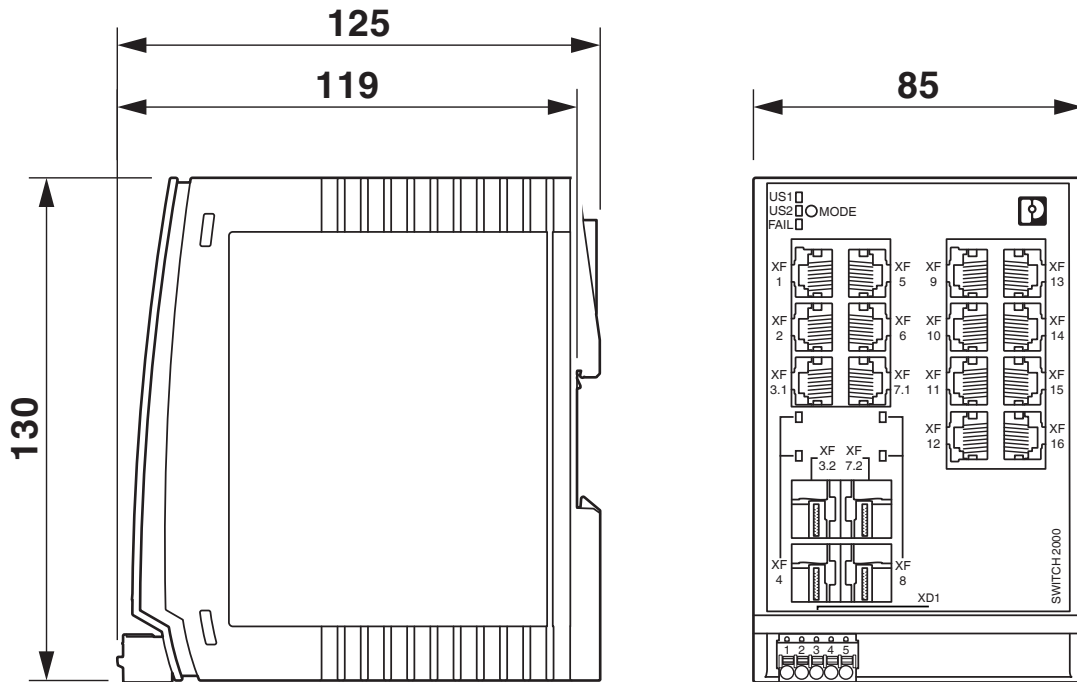

Industrial Ethernet Switch - FL SWITCH 2212-2TC-2SFX



2702907

<https://www.phoenixcontact.com/us/products/2702907>

Approvals



EAC

Approval ID: RU*-DE.*.B.00741/19



DNV GL

Approval ID: TAA00000YV



LR

Approval ID: LR22250919TA



NK

Approval ID: TA19464M



BV

Approval ID: 48146/A1 BV



UL Listed

Approval ID: FILE E 238705



cUL Listed

Approval ID: FILE E 238705

BSH

Approval ID: 1045



RINA

Approval ID: ELE162721XG

ABS

Approval ID: 21-2066186-PDA



IECEX

Approval ID: IECEX ULD 16.0018X



cUL Listed

Approval ID: FILE E 366272

Industrial Ethernet Switch - FL SWITCH 2212-2TC-2SFX



2702907

<https://www.phoenixcontact.com/us/products/2702907>



UL Listed

Approval ID: FILE E 366272



ATEX

Approval ID: DEMKO 16 ATEX 1709X

cULus Listed

cULus Listed

Industrial Ethernet Switch - FL SWITCH 2212-2TC-2SFX



2702907

<https://www.phoenixcontact.com/us/products/2702907>

Classifications

ECLASS

ECLASS-9.0	19170106
ECLASS-10.0.1	19170401
ECLASS-11.0	19170401

ETIM

ETIM 8.0	EC000734
----------	----------

UNSPSC

UNSPSC 21.0	43222600
-------------	----------

Industrial Ethernet Switch - FL SWITCH 2212-2TC-2SFX



2702907

<https://www.phoenixcontact.com/us/products/2702907>

Environmental Product Compliance

REACH SVHC	Lead 7439-92-1
China RoHS	Environmentally Friendly Use Period = 50 years
	For information on hazardous substances, refer to the manufacturer's declaration available under "Downloads"

Industrial Ethernet Switch - FL SWITCH 2212-2TC-2SFX



2702907

<https://www.phoenixcontact.com/us/products/2702907>

Accessories

Program / configuration memory

Program / configuration memory - SD FLASH 512MB - 2988146

<https://www.phoenixcontact.com/us/products/2988146>

Program and configuration memory, plug-in, 512 Mbyte.



Program / configuration memory

Program / configuration memory - SD FLASH 2GB - 2988162

<https://www.phoenixcontact.com/us/products/2988162>

Program and configuration memory, for extending the internal flash memory, pluggable, 2 GB.



Industrial Ethernet Switch - FL SWITCH 2212-2TC-2SFX



2702907

<https://www.phoenixcontact.com/us/products/2702907>

Network management software

Network management software - FL NETWORK MANAGER BASIC - 2702889

<https://www.phoenixcontact.com/us/products/2702889>

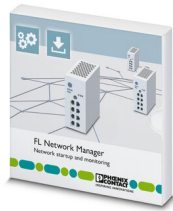

FL Network Manager, SNMP-based configuration and firmware update software, for easy startup of Managed Switches

DIN rail adapter

DIN rail adapter - FL DIN RA - 2891053

<https://www.phoenixcontact.com/us/products/2891053>

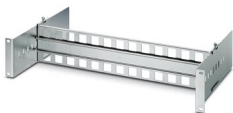

The FL DIN RA is installed in a standard, 19-inch rack (EIA-310-D, IEC 60297-3-100) to allow DIN rail mounted equipment to be rack mounted.

Industrial Ethernet Switch - FL SWITCH 2212-2TC-2SFX

2702907

<https://www.phoenixcontact.com/us/products/2702907>

Dust protection

Dust protection - FL RJ45 PROTECT CAP - 2832991

<https://www.phoenixcontact.com/us/products/2832991>

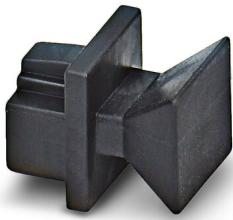

Dust protection caps for RJ45 socket

End clamp

End clamp - E/NS 35 N - 0800886

<https://www.phoenixcontact.com/us/products/0800886>

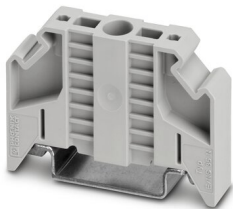

End clamp, width: 9.5 mm, color: gray

Industrial Ethernet Switch - FL SWITCH 2212-2TC-2SFX



2702907

<https://www.phoenixcontact.com/us/products/2702907>

PCB connector

PCB connector - FK-MCP 1,5/ 5-ST-3,81GY35BD1-5 - 1015782

<https://www.phoenixcontact.com/us/products/1015782>



PCB connector, nominal cross section: 1.5 mm², color: light grey, nominal current: 8 A, rated voltage (III/2): 160 V, contact surface: Tin, type of contact: Female connector, number of potentials: 5, number of rows: 1, number of positions: 5, number of connections: 5, product range: FK-MCP 1,5/...-ST, pitch: 3.81 mm, connection method: Push-in spring connection, conductor/PCB connection direction: 0 °, number of solder pins per potential: 1, plug-in system: COMBICON MC 1,5, locking: without, mounting: without, type of packaging: packed in cardboard

Media module

Media module - FL SFP FX - 2891081

<https://www.phoenixcontact.com/us/products/2891081>



The small form-factor plug-in module provides a fiber optic interface with a data transmission speed of 100 Mbps with a wavelength of 1310 nm (long).

Industrial Ethernet Switch - FL SWITCH 2212-2TC-2SFX

2702907

<https://www.phoenixcontact.com/us/products/2702907>

Media module

Media module - FL SFP FX SM - 2891082

<https://www.phoenixcontact.com/us/products/2891082>



The small form-factor plug-in module provides a fiber optic interface with a data transmission speed of 100 Mbps with a wavelength of 1310 nm (long).

Media module

Media module - FL SFP FE WDM20-SET - 2702439

<https://www.phoenixcontact.com/us/products/2702439>



Fast Ethernet SFP WDM set for transmission up to a maximum of 20 km on a single fiber with a wavelength of 1310/1550 nm.

Industrial Ethernet Switch - FL SWITCH 2212-2TC-2SFX

2702907

<https://www.phoenixcontact.com/us/products/2702907>

PCB connector

PCB connector - MCVW 1,5/ 5-ST-3,81GY7035BD2DO - 1034096

<https://www.phoenixcontact.com/us/products/1034096>



PCB connector, nominal cross section: 1.5 mm², color: light grey, nominal current: 8 A, rated voltage (III/2): 160 V, contact surface: Tin, type of contact: Female connector, number of potentials: 5, number of rows: 1, number of positions: 5, number of connections: 5, product range: MCVW 1,5/...-ST, pitch: 3.81 mm, connection method: Screw connection with tension sleeve, screw head form: L Slotted, conductor/PCB connection direction: -90 °, number of solder pins per potential: 1, plug-in system: COMBICON MC 1,5, locking: without, mounting: without, type of packaging: packed in cardboard

Patch cable

Patch cable - FL CAT5 PATCH 0,5 - 2832263

<https://www.phoenixcontact.com/us/products/2832263>



Patch cable, CAT5, assembled, 0.5 m

Industrial Ethernet Switch - FL SWITCH 2212-2TC-2SFX

2702907

<https://www.phoenixcontact.com/us/products/2702907>

Patch cable

Patch cable - FL CAT5 PATCH 1,0 - 2832276

<https://www.phoenixcontact.com/us/products/2832276>

Patch cable, CAT5, assembled, 1 m



Patch cable

Patch cable - FL CAT5 PATCH 2,0 - 2832289

<https://www.phoenixcontact.com/us/products/2832289>

Patch cable, CAT5, assembled, 2 m



Industrial Ethernet Switch - FL SWITCH 2212-2TC-2SFX

2702907

<https://www.phoenixcontact.com/us/products/2702907>

Patch cable

Patch cable - NBC-R4AC-R4AC-IE8A/.../... - 1411854

<https://www.phoenixcontact.com/us/products/1411854>

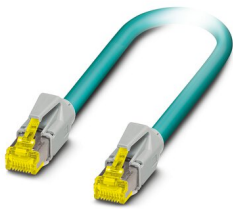

Patch cable, degree of protection: IP20, number of positions: 8, 10 Gbps, CAT6_A, cable outlet: straight, Ethernet

Patch cable

Patch cable - NBC-R4AC/10G-R4AC/10G-94F/2,0 - 1408360

<https://www.phoenixcontact.com/us/products/1408360>

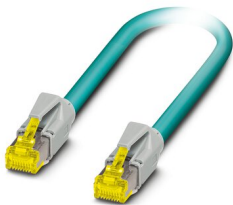

Patch cable, CAT6_A, 4-pair, shielded, connection not crossed (line), assembled at both ends with RJ45/IP20 connectors, outer sheath material: PUR, length: 2.0 m

Industrial Ethernet Switch - FL SWITCH 2212-2TC-2SFX

2702907

<https://www.phoenixcontact.com/us/products/2702907>

Patch cable

Patch cable - NBC-R4AC/10G-R4AC/10G-94F/3,0 - 1408365

<https://www.phoenixcontact.com/us/products/1408365>

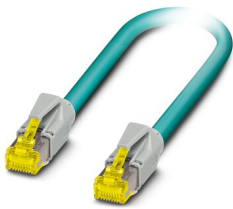

Patch cable, CAT6_A, 4-pair, shielded, connection not crossed (line), assembled at both ends with RJ45/IP20 connectors, outer sheath material: PUR, length: 3.0 m

Patch cable

Patch cable - NBC-R4AC/1,0-93B/R4AC - 1408968

<https://www.phoenixcontact.com/us/products/1408968>



Patch cable, degree of protection: IP20, cable length: 1 m, number of positions: 4, 100 Mbps, CAT5, material: PA 6.6, PROFINET

Industrial Ethernet Switch - FL SWITCH 2212-2TC-2SFX



2702907

<https://www.phoenixcontact.com/us/products/2702907>

Patch cable

Patch cable - NBC-R4AC/2,0-93B/R4AC - 1408969

<https://www.phoenixcontact.com/us/products/1408969>



Patch cable, degree of protection: IP20, cable length: 2 m, number of positions: 4, 100 Mbps, CAT5, material: PA 6.6, PROFINET

Patch cable

Patch cable - NBC-R4AC/5,0-93B/R4AC - 1408970

<https://www.phoenixcontact.com/us/products/1408970>



Patch cable, degree of protection: IP20, cable length: 5 m, number of positions: 4, 100 Mbps, CAT5, material: PA 6.6, PROFINET

Industrial Ethernet Switch - FL SWITCH 2212-2TC-2SFX

2702907

<https://www.phoenixcontact.com/us/products/2702907>

FO patch cable

FO patch cable - FOC-LC:PA-SC:PA-OM2:D01/1 - 1115607

<https://www.phoenixcontact.com/us/products/1115607>

Multi-mode OM2 duplex jumper, LC-SC, UPC polishing, length 1 m

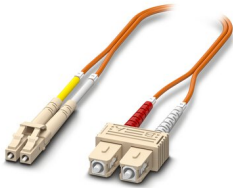

FO patch cable

FO patch cable - FOC-LC:PA-SC:PA-OM2:D01/2 - 1115605

<https://www.phoenixcontact.com/us/products/1115605>

Multi-mode OM2 duplex jumper, LC-SC, UPC polishing, length 2 m

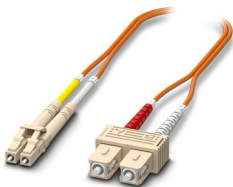

Industrial Ethernet Switch - FL SWITCH 2212-2TC-2SFX

2702907

<https://www.phoenixcontact.com/us/products/2702907>

FO patch cable

FO patch cable - FOC-LC:PA-LC:PA-OM2:D01/1 - 1115633

<https://www.phoenixcontact.com/us/products/1115633>

Multi-mode OM2 duplex jumper, LC-LC, UPC polishing, length 1 m

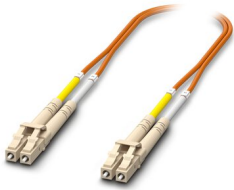

FO patch cable

FO patch cable - FOC-LC:PA-LC:PA-OM2:D01/2 - 1115634

<https://www.phoenixcontact.com/us/products/1115634>

Multi-mode OM2 duplex jumper, LC-LC, UPC polishing, length 2 m

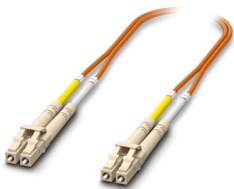

Industrial Ethernet Switch - FL SWITCH 2212-2TC-2SFX

2702907

<https://www.phoenixcontact.com/us/products/2702907>

Fiber optic cable

Fiber optic cable - FOC-LC:PA-ST:PA-OM2:D01/1 - 1115588

<https://www.phoenixcontact.com/us/products/1115588>

Multi-mode OM2 duplex jumper, LC-ST, UPC polishing, length 1 m

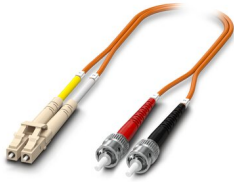

Fiber optic cable

Fiber optic cable - FOC-LC:PA-ST:PA-OM2:D01/2 - 1115587

<https://www.phoenixcontact.com/us/products/1115587>

Multi-mode OM2 duplex jumper, LC-ST, UPC polishing, length 2 m

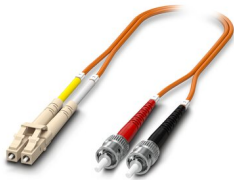

Industrial Ethernet Switch - FL SWITCH 2212-2TC-2SFX

2702907

<https://www.phoenixcontact.com/us/products/2702907>

FO patch cable

FO patch cable - FOC-LC:PA-SC:PA-OM4:D01/1 - 1115601

<https://www.phoenixcontact.com/us/products/1115601>

Multi-mode OM4 duplex jumper, LC-SC, UPC polishing, length 1 m

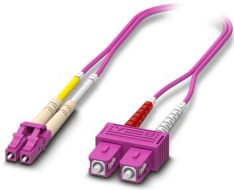

FO patch cable

FO patch cable - FOC-LC:PA-SC:PA-OM4:D01/2 - 1115600

<https://www.phoenixcontact.com/us/products/1115600>

Multi-mode OM4 duplex jumper, LC-SC, UPC polishing, length 2 m

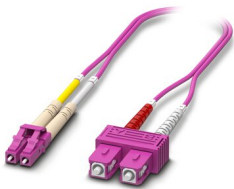

Industrial Ethernet Switch - FL SWITCH 2212-2TC-2SFX

2702907

<https://www.phoenixcontact.com/us/products/2702907>

FO patch cable

FO patch cable - FOC-LC:PA-LC:PA-OM4:D01/1 - 1115625

<https://www.phoenixcontact.com/us/products/1115625>

Multi-mode OM4 duplex jumper, LC-LC, UPC polishing, length 1 m

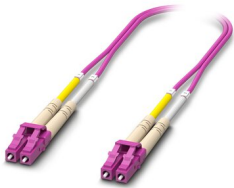

FO patch cable

FO patch cable - FOC-LC:PA-LC:PA-OM4:D01/2 - 1115624

<https://www.phoenixcontact.com/us/products/1115624>

Multi-mode OM4 duplex jumper, LC-LC, UPC polishing, length 2 m

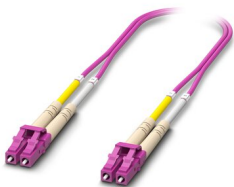

Industrial Ethernet Switch - FL SWITCH 2212-2TC-2SFX

2702907

<https://www.phoenixcontact.com/us/products/2702907>

FO patch cable

FO patch cable - FOC-LC:PA-LC:PA-OS2:D01/1 - 1115636

<https://www.phoenixcontact.com/us/products/1115636>

Single-mode OS2 duplex jumper, LC-LC, UPC polishing, length 1 m

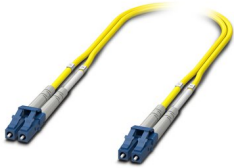

FO patch cable

FO patch cable - FOC-LC:PA-LC:PA-OS2:D01/2 - 1115629

<https://www.phoenixcontact.com/us/products/1115629>

Single-mode OS2 duplex jumper, LC-LC, UPC polishing, length 2 m

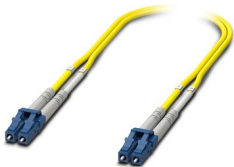

Industrial Ethernet Switch - FL SWITCH 2212-2TC-2SFX



2702907

<https://www.phoenixcontact.com/us/products/2702907>

FO patch cable

FO patch cable - FOC-LC:PA-ST:PA-OS2:D01/1 - 1115596

<https://www.phoenixcontact.com/us/products/1115596>

Single-mode OS2 duplex jumper, LC-ST, UPC polishing, length 1 m



FO patch cable

FO patch cable - FOC-LC:PA-ST:PA-OS2:D01/2 - 1115595

<https://www.phoenixcontact.com/us/products/1115595>

Single-mode OS2 duplex jumper, LC-ST, UPC polishing, length 2 m



Industrial Ethernet Switch - FL SWITCH 2212-2TC-2SFX

2702907

<https://www.phoenixcontact.com/us/products/2702907>

FO patch cable

FO patch cable - FOC-LC:PA-SC:PA-OS2:D01/1 - 1115618

<https://www.phoenixcontact.com/us/products/1115618>

Single-mode OS2 duplex jumper, LC-SC, UPC polishing, length 1 m

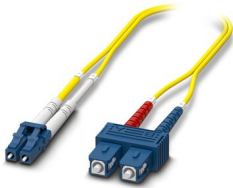

FO patch cable

FO patch cable - FOC-LC:PA-SC:PA-OS2:D01/2 - 1115617

<https://www.phoenixcontact.com/us/products/1115617>

Single-mode OS2 duplex jumper, LC-SC, UPC polishing, length 2 m

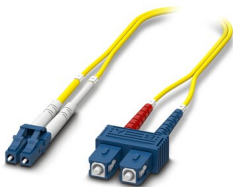

Industrial Ethernet Switch - FL SWITCH 2212-2TC-2SFX



2702907

<https://www.phoenixcontact.com/us/products/2702907>

RJ45 connector

RJ45 connector - VS-08-RJ45-5-Q/IP20 - 1656725

<https://www.phoenixcontact.com/us/products/1656725>



RJ45 connector, degree of protection: IP20, number of positions: 8, 1 Gbps, CAT5 (IEC 11801:2002), material: PA, connection method: IDC fast connection, connection cross section: AWG 26- 23, cable outlet: straight, color: traffic grey A RAL 7042, Ethernet

Phoenix Contact 2022 © - all rights reserved

<https://www.phoenixcontact.com>

Phoenix Contact USA
586 Fulling Mill Road
Middletown, PA 17057, United States
(+717) 944-1300
info@phoenixcon.com